

## SMALL BUBBLE CHANDELIER

**Collection:**

Bubble Chandeliers

**Design Year:**

2017

**Dimensions:**

Diam 13in/33cm x H 13in/33cm

**Weight:**

4lbs/1.8kg

**Specifications (120V):**

2x G30 Bulbs (40W) included / Clear / E26 Medium Screw Base / 80W total / 760 Lumens total  
 LED Bulbs upon request

**Specifications (240V):**

2x G95 Bulbs (40W) included / Clear / E27 Medium Screw Base / 80W total / 780 Lumens total  
 LED Bulbs upon request

**Suspension:**

White or black lamp cord with 5" white or black canopy.  
 Ships with 6ft/1.8m standard cord length.

**Materials:**

Machined brass and aluminum, hand-blown glass globes, decorative cotton or leather coiling

**Metal Finish Options:**

Satin Brass, Polished Nickel

**Decorative Coiling Options:**

Standard: Natural Cotton Cord  
 Upgrades: White, Natural, Henna, Iris Blue, Dark-Brown, Grey and Black Leather Cord.  
 Custom leather colors available upon request.

**Certifications:**



**Made in:**

New York, USA



Pictured with Satin Brass and Natural Cotton Cord

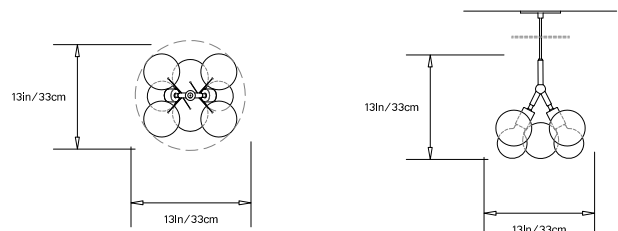

## ORIGINAL BUBBLE CHANDELIER

### Collection:

Bubble Chandeliers

### Design Year:

2008

### Dimensions:

Diam 18in/46cm x H 22in/56cm

### Weight:

10lbs/4.5kg

### Specifications (120V):

3x G30 Bulbs (40W) included / Clear / E26 Medium Screw Base / 120W total / 1140 Lumens total LED Bulbs upon request

### Specifications (240V):

3x G95 Bulbs (40W) included / Clear / E27 Medium Screw Base / 120W total / 1170 Lumens total LED Bulbs upon request

### Suspension:

0.5in stem and 6in canopy in matching metal finish. Ships with 2ft/60cm long stem that can be adjusted on site. Longer pipe lengths available upon request.

### Materials:

Machined brass and aluminum, hand-blown glass globes, decorative cotton or leather coiling

### Metal Finish Options:

Standard: Satin Brass, Polished Nickel  
 Upgrades: Brushed Nickel, Antique Brass, Dark Bronze, Black Brass

### Glass Globe Options:

Standard: Clear  
 Upgrades: Opalescent, 24 gold/silver gilded, hand-painted. Please refer to the 'Materials and Finish Options' Guide for further information.

### Decorative Coiling Options:

Standard: Natural Cotton Cord  
 Upgrades: White, Natural, Henna, Iris Blue, Dark Brown, Grey and Black Leather Cord.  
 Custom leather colors available upon request.

### Certifications:



### Made in:

New York, USA



Pictured with Satin Brass and Natural Cotton Cord

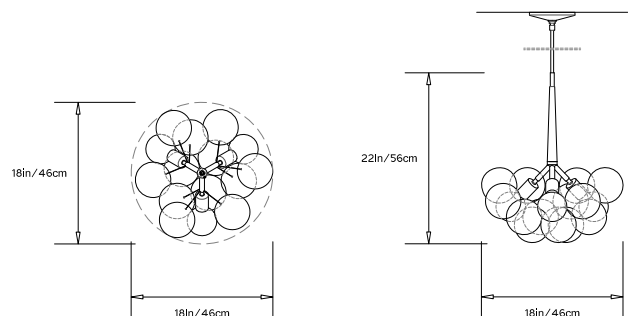

## LARGE BUBBLE CHANDELIER

**Collection:**

Bubble Chandeliers

**Design Year:**

2009

**Dimensions:**

Diam 21.5in/55cm x H 24in/61cm

**Weight:**

11.5lbs/5.2kg

**Specifications (120V):**

3x G40 Bulbs (40W) included / Clear / E26 Medium Screw Base / 120W total / 900 Lumens total  
 LED Bulbs upon request

**Specifications (240V):**

3x G125 Bulbs (40W) included / Clear / E27 Medium Screw Base / 120W total / 1170 Lumens total  
 LED Bulbs upon request

**Suspension:**

0.5in stem and 6in canopy in matching metal finish. Ships with 2ft/60cm long stem that can be adjusted on site. Longer pipe lengths available upon request.

**Materials:**

Machined brass and aluminum, hand-blown glass globes, decorative cotton or leather coiling

**Metal Finish Options:**

Standard: Satin Brass, Polished Nickel  
 Upgrades: Brushed Nickel, Antique Brass, Dark Bronze, Black Brass

**Glass Globe Options:**

Standard: Clear  
 Upgrades: Opalescent, 24 gold/silver gilded, hand-painted. Please refer to the 'Materials and Finish Options' Guide for further information.

**Decorative Coiling Options:**

Standard: Natural Cotton Cord  
 Upgrades: White, Natural, Henna, Iris Blue, Dark Brown, Grey and Black Leather Cord.  
 Custom leather colors available upon request.

**Certifications:**



**Made in:**

New York, USA



Pictured with Polished Nickel and White Leather Cord

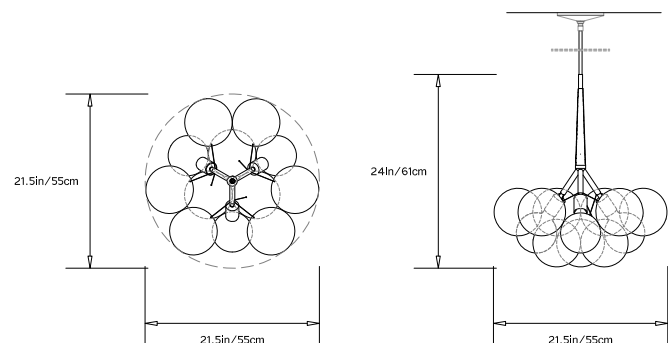

## X-LARGE BUBBLE CHANDELIER

**Collection:**

Bubble Chandeliers

**Design Year:**

2009

**Dimensions:**

Diam 26in/66cm x H 25in/63cm

**Weight:**

13lbs/5.9kg

**Specifications (120V):**

4x G40 Bulbs (40W) included / Clear / E26 Medium Screw Base / 160W total / 1200 Lumens total LED Bulbs upon request

**Specifications (240V):**

4x G125 Bulbs (40W) included / Clear / E27 Medium Screw Base / 160W total / 1560 Lumens total LED Bulbs upon request

**Suspension:**

0.5in stem and 6in canopy in matching metal finish. Ships with 2ft/60cm long stem that can be adjusted on site. Longer pipe lengths available upon request.

**Materials:**

Machined brass and aluminum, hand-blown glass globes, decorative cotton or leather coiling

**Metal Finish Options:**

Standard: Satin Brass, Polished Nickel  
 Upgrades: Brushed Nickel, Antique Brass, Dark Bronze, Black Brass

**Glass Globe Options:**

Standard: Clear  
 Upgrades: Opalescent, 24 gold/silver gilded, hand-painted. Please refer to the 'Materials and Finish Options' Guide for further information.

**Decorative Coiling Options:**

Standard: Natural Cotton Cord  
 Upgrades: White, Natural, Henna, Iris Blue, Dark Brown, Grey and Black Leather Cord.  
 Custom leather colors available upon request.

**Certifications:**



**Made in:**

New York, USA



Pictured with Satin Brass and Natural Cotton Cord

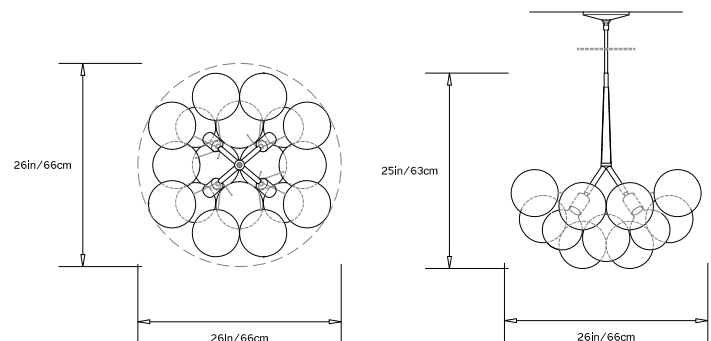

## JUMBO BUBBLE CHANDELIER

### Collection:

Bubble Chandeliers

### Design Year:

2010

### Dimensions:

Diam 29in/74cm x H 28in/71cm

### Weight:

17lbs/7.7kg

### Specifications (120V):

6x G40 Bulbs (40W) included / Clear / E26 Medium Screw Base / 240W total / 1800 Lumens total LED Bulbs upon request

### Specifications (240V):

6x G125 Bulbs (40W) included / Clear / E27 Medium Screw Base / 240W total / 2340 Lumens total LED Bulbs upon request

### Suspension:

0.5in stem and 6in canopy in matching metal finish. Ships with 2ft/60cm long stem that can be adjusted on site. Longer pipe lengths available upon request.

### Materials:

Machined brass and aluminum, hand-blown glass globes, decorative cotton or leather coiling

### Metal Finish Options:

Standard: Satin Brass, Polished Nickel  
 Upgrades: Brushed Nickel, Antique Brass, Dark Bronze, Black Brass

### Glass Globe Options:

Standard: Clear  
 Upgrades: Opalescent, 24 gold/silver gilded, hand-painted. Please refer to the 'Materials and Finish Options' Guide for further information.

### Decorative Coiling Options:

Standard: Natural Cotton Cord  
 Upgrades: White, Natural, Henna, Iris Blue, Dark Brown, Grey and Black Leather Cord.  
 Custom leather colors available upon request.

### Certifications:



### Made in:

New York, USA



Pictured with Satin Brass  
and Iris Blue Leather Cord

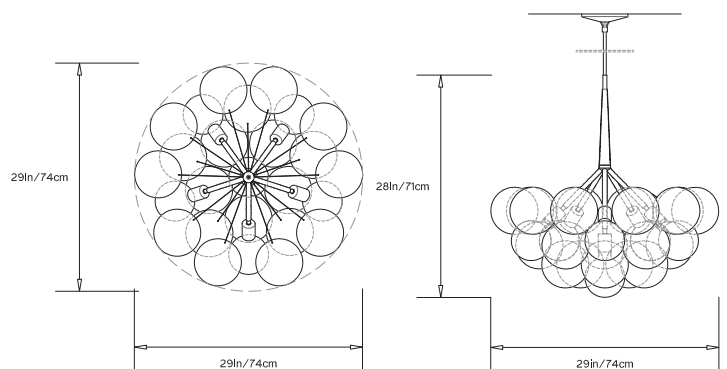

## SUPRA BUBBLE CHANDELIER

**Collection:**

Bubble Chandeliers

**Design Year:**

2016

**Dimensions:**

Diam 38in/97cm x H 30in/76cm

**Weight:**

30lbs/13.6kg

**Specifications (120V):**

11x G40 Bulbs (40W) included / Clear / E26 Medium Screw Base / 440W total / 3300 Lumens total  
 LED Bulbs upon request

**Specifications (240V):**

11x G125 Bulbs (40W) included / Clear / E27 Medium Screw Base / 440W total / 4290 Lumens total  
 LED Bulbs upon request

**Suspension:**

0.625in stem and 6in canopy in matching metal finish.  
 Ships with 2ft/60cm long stem that can be adjusted on site. Longer pipe lengths available upon request.

**Materials:**

Machined brass and aluminum, hand-blown glass globes, decorative cotton or leather coiling

**Metal Finish Options:**

Standard: Satin Brass, Polished Nickel  
 Upgrades: Brushed Nickel, Antique Brass, Dark Bronze, Black Brass

**Glass Globe Options:**

Standard: Clear  
 Upgrades: Opalescent, 24 gold/silver gilded, hand-painted. Please refer to the 'Materials and Finish Options' Guide for further information.

**Decorative Coiling Options:**

Standard: Natural Cotton Cord  
 Upgrades: White, Natural, Henna, Iris Blue, Dark Brown, Grey and Black Leather Cord.  
 Custom leather colors available upon request.

**Certifications:**



**Made in:**

New York, USA



Pictured with Satin Brass  
 and Dark Brown Leather Cord

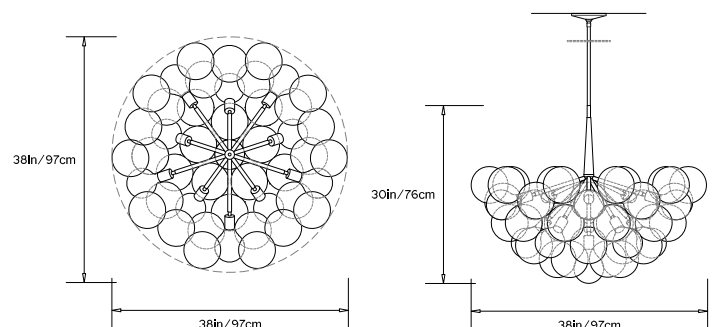

## PENDANT BUBBLE CHANDELIER

**Collection:**

Bubble Chandeliers

**Design Year:**

2011

**Dimensions:**

Diam 14in/36cm. x H 29in/74cm

**Weight:**

13lbs/5.9kg

**Specifications (120V):**

3x G40 Bulbs (40W) included / Clear / E26 Medium Screw Base / 120W total / 900 Lumens total  
 LED Bulbs upon request

**Specifications (240V):**

3x G125 Bulbs (40W) included / Clear / E27 Medium Screw Base / 120W total / 1170 Lumens total  
 LED Bulbs upon request

**Suspension:**

0.5in stem and 6in canopy in matching metal finish.  
 Ships with 2ft/60cm long stem that can be adjusted on site. Longer pipe lengths available upon request.

**Materials:**

Machined brass and aluminum, hand-blown glass globes, decorative cotton or leather coiling

**Metal Finish Options:**

Standard: Satin Brass, Polished Nickel  
 Upgrades: Brushed Nickel, Antique Brass, Dark Bronze, Black Brass

**Glass Globe Options:**

Standard: Clear  
 Upgrades: Opalescent, 24 gold/silver gilded, hand-painted. Please refer to the 'Materials and Finish Options' Guide for further information.

**Decorative Coiling Options:**

Standard: Natural Cotton Cord  
 Upgrades: White, Natural, Henna, Iris Blue, Dark Brown, Grey and Black Leather Cord.  
 Custom leather colors available upon request.

**Certifications:**

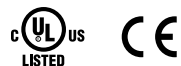

**Made in:**

New York, USA



Pictured with Polished Nickel and Dark Brown Leather Cord

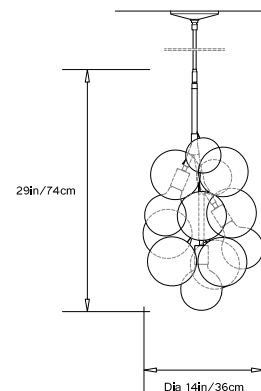

## TALL BUBBLE CHANDELIER

**Collection:**

Bubble Chandeliers

**Design Year:**

2010

**Dimensions:**

Diam 15in/38cm x H 47in/119cm  
 Custom height options available

**Weight:**

18lbs/8.2kg

**Specifications (120V):**

4x G40 Bulbs (40W) included / Clear / E26 Medium  
 Screw Base / 160W total / 1200 Lumens total  
 LED Bulbs upon request

**Specifications (240V):**

4x G125 Bulbs (40W) included / Clear / E27 Medium  
 Screw Base / 160W total / 1560 Lumens total  
 LED Bulbs upon request

**Suspension:**

0.5in stem and 6in canopy in matching metal finish.  
 Ships with 2ft/60cm long stem that can be adjusted on  
 site. Longer pipe lengths available upon request.

**Materials:**

Machined brass and aluminum, hand-blown glass  
 globes, decorative cotton or leather coiling

**Metal Finish Options:**

Standard: Satin Brass, Polished Nickel  
 Upgrades: Brushed Nickel, Antique Brass, Dark Bronze,  
 Black Brass

**Glass Globe Options:**

Standard: Clear  
 Upgrades: Opalescent, 24 gold/silver gilded,  
 hand-painted. Please refer to the 'Materials and Finish  
 Options' Guide for further information.

**Decorative Coiling Options:**

Standard: Natural Cotton Cord  
 Upgrades: White, Natural, Henna, Iris Blue,  
 Dark Brown, Grey and Black Leather Cord.  
 Custom leather colors available upon request.

**Certifications:**



**Made in:**

New York, USA



Pictured with Satin Brass  
 and Natural Cotton Cord

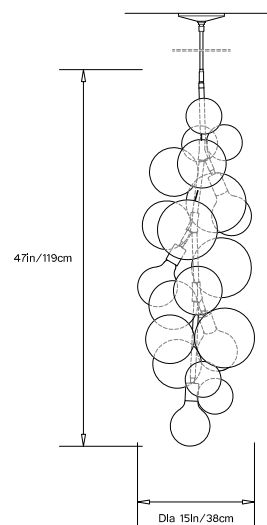



## X-TALL BUBBLE CHANDELIER

**Collection:**

Bubble Chandeliers

**Design Year:**

2011

**Dimensions:**

Diam 18in/46cm x H 60in/152cm  
 Custom height options available

**Weight:**

24lbs/10.9kg

**Specifications (120V):**

5x G40 Bulbs (40W) included / Clear / E26 Medium  
 Screw Base / 200W total / 1500 Lumens total  
 LED Bulbs upon request

**Specifications (240V):**

5x G125 Bulbs (40W) included / Clear / E27 Medium  
 Screw Base / 200W total / 1950 Lumens total  
 LED Bulbs upon request

**Suspension:**

0.5in stem and 6in canopy in matching metal finish.  
 Ships with 2ft/60cm long stem that can be adjusted on  
 site. Longer pipe lengths available upon request.

**Materials:**

Machined brass and aluminum, hand-blown glass  
 globes, decorative cotton or leather coiling

**Metal Finish Options:**

Standard: Satin Brass, Polished Nickel  
 Upgrades: Brushed Nickel, Antique Brass, Dark Bronze,  
 Black Brass

**Glass Globe Options:**

Standard: Clear  
 Upgrades: Opalescent, 24 gold/silver gilded,  
 hand-painted. Please refer to the 'Materials and Finish  
 Options' Guide for further information.

**Decorative Coiling Options:**

Standard: Natural Cotton Cord  
 Upgrades: White, Natural, Henna, Iris Blue,  
 Dark Brown, Grey and Black Leather Cord.  
 Custom leather colors available upon request.

**Certifications:**

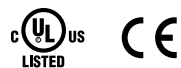

**Made in:**

New York, USA



Pictured with Satin Brass  
 and White Leather Cord

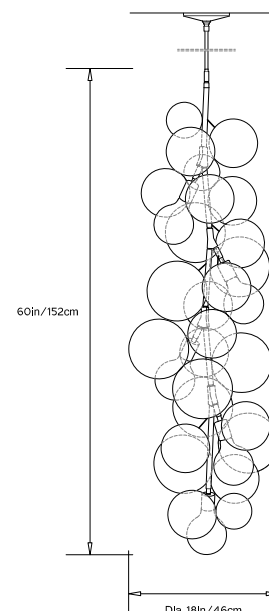

## LONG 48 BUBBLE CHANDELIER

**Collection:**

Bubble Chandeliers

**Design Year:**

2013

**Dimensions:**

L 48in/122cm x H 16in/40cm x W 17in/43cm  
 Dimensions will vary slightly  
 Also available in 62", 80" and 96" length

**Weight:**

15-18lbs/6.8-8.2kg

**Specifications (120V):**

5x G40 Bulbs (40W) included / Clear / E26 Medium Screw Base / 200W total / 1500 Lumens total  
 LED Bulbs upon request

**Specifications (240V):**

5x G125 Bulbs (40W) included / Clear / E27 Medium Screw Base / 200W total / 1950 Lumens total  
 LED Bulbs upon request

**Suspension:**

Steel cable or fixed pipe suspension. Please refer to configuration options in separate "Suspension Options Guide".

**Materials:**

Machined brass, hand-blown glass globes, decorative cotton or leather coiling

**Metal Finish Options:**

Standard: Satin Brass, Polished Nickel  
 Upgrades: Brushed Nickel, Antique Brass, Dark Bronze, Black Brass

**Glass Globe Options:**

Standard: Clear  
 Upgrades: Opalescent, 24 gold/silver gilded, hand-painted. Please refer to the 'Materials and Finish Options' Guide for further information.

**Decorative Coiling Options:**

Standard: Natural Cotton Cord  
 Upgrades: White, Natural, Henna, Iris Blue, Dark Brown, Grey and Black Leather Cord.  
 Custom leather colors available upon request.

**Certifications:**



**Made in:**

New York, USA



Pictured with Opalescent Globes, Polished Nickel and Black Leather Cord, Figure 3 suspension configuration

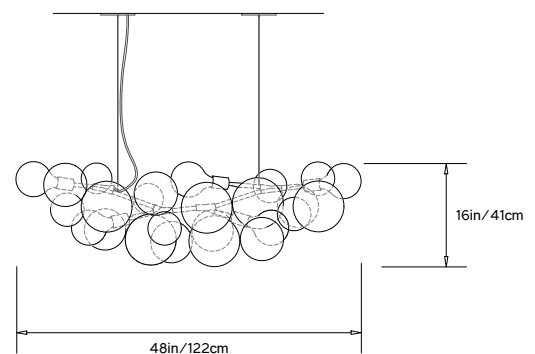

## LONG 62 BUBBLE CHANDELIER

### Collection:

Bubble Chandeliers

### Design Year:

2013

### Dimensions:

L 62in/158cm x H 16in/40cm x W 18in/46cm  
 Dimensions will vary slightly  
 Also available in 48", 80" and 96" length

### Weight:

17-20lbs/7.7-9.1kg

### Specifications (120V):

6x G40 Bulbs (40W) included / Clear / E26 Medium Screw Base / 240W total / 1800 Lumens total  
 LED Bulbs upon request

### Specifications (240V):

6x G125 Bulbs (40W) included / Clear / E27 Medium Screw Base / 240W total / 2340 Lumens total  
 LED Bulbs upon request

### Suspension:

Steel cable or fixed pipe suspension. Please refer to configuration options in separate "Suspension Options Guide".

### Materials:

Machined brass, hand-blown glass globes, decorative cotton or leather coiling

### Metal Finish Options:

Standard: Satin Brass, Polished Nickel  
 Upgrades: Brushed Nickel, Antique Brass, Dark Bronze, Black Brass

### Glass Globe Options:

Standard: Clear  
 Upgrades: Opalescent, 24 gold/silver gilded, hand-painted. Please refer to the 'Materials and Finish Options' Guide for further information.

### Decorative Coiling Options:

Standard: Natural Cotton Cord  
 Upgrades: White, Natural, Henna, Iris Blue, Dark Brown, Grey and Black Leather Cord.  
 Custom leather colors available upon request.

### Certifications:



### Made in:

New York, USA



Pictured with Polished Nickel and Henna Leather Cord, Figure 1 suspension configuration

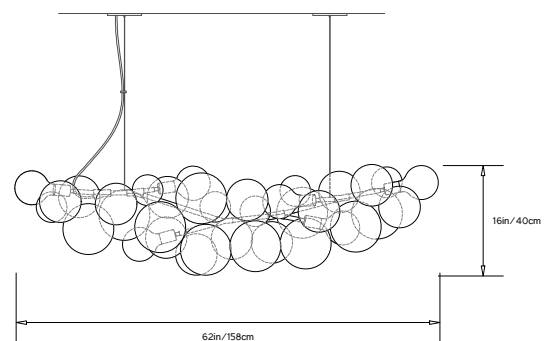

## LONG 80 BUBBLE CHANDELIER

**Collection:**

Bubble Chandeliers

**Design Year:**

2013

**Dimensions:**

L 80in/203cm x H 17in/43cm x W 26in/66cm  
 Dimensions will vary slightly

Also available in 48", 62" and 96" length

**Weight:**

35-40lbs/15.8-18.1kg

**Specifications (120V):**

8x G40 Bulbs (40W) included / Clear / E26 Medium Screw Base / 240W total / 2400 Lumens total  
 LED Bulbs upon request

**Specifications (240V):**

8x G125 Bulbs (40W) included / Clear / E27 Medium Screw Base / 240W total / 3120 Lumens total  
 LED Bulbs upon request

**Suspension:**

Steel cable or fixed pipe suspension. Please refer to configuration options in separate "Suspension Options Guide".

**Materials:**

Machined brass, hand-blown glass globes, decorative cotton or leather coiling

**Metal Finish Options:**

Standard: Satin Brass, Polished Nickel  
 Upgrades: Brushed Nickel, Antique Brass, Dark Bronze, Black Brass

**Glass Globe Options:**

Standard: Clear  
 Upgrades: Opalescent, 24 gold/silver gilded, hand-painted. Please refer to the 'Materials and Finish Options' Guide for further information.

**Decorative Coiling Options:**

Standard: Natural Cotton Cord  
 Upgrades: White, Natural, Henna, Iris Blue, Dark Brown, Grey and Black Leather Cord.  
 Custom leather colors available upon request.

**Certifications:**

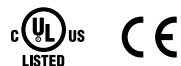

**Made in:**

New York, USA



Pictured with Satin Brass, Natural Cotton Cord and Hand-painted Strokes Finish, Figure 1 suspension configuration

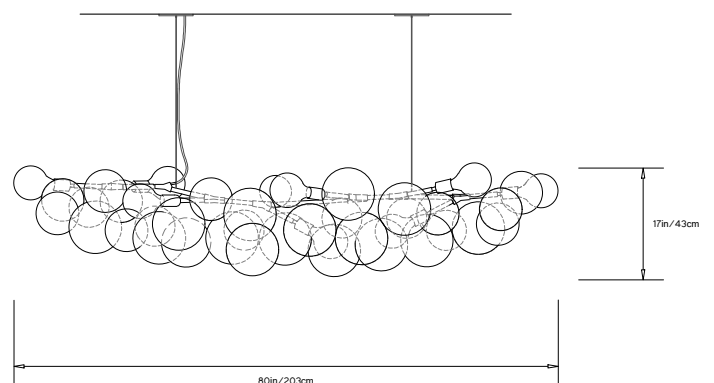

## LONG 96 BUBBLE CHANDELIER

**Collection:**

Bubble Chandeliers

**Design Year:**

2013

**Dimensions:**

L 96in/244cm x H 17in/43cm x W 23in/59cm  
 Dimensions will vary slightly

Also available in 48", 62" and 80" length

**Weight:**

40-45lbs/20.4kg

**Specifications (120V):**

9x G40 Bulbs (40W) included / Clear / E26 Medium Screw Base / 240W total / 2700 Lumens total  
 LED Bulbs upon request

**Specifications (240V):**

9x G125 Bulbs (40W) included / Clear / E27 Medium Screw Base / 240W total / 3510 Lumens total  
 LED Bulbs upon request

**Suspension:**

Steel cable or fixed pipe suspension. Please refer to configuration options in separate "Suspension Options Guide".

**Materials:**

Machined brass, hand-blown glass globes, decorative cotton or leather coiling

**Metal Finish Options:**

Standard: Satin Brass, Polished Nickel  
 Upgrades: Brushed Nickel, Antique Brass, Dark Bronze, Black Brass

**Glass Globe Options:**

Standard: Clear  
 Upgrades: Opalescent, 24 gold/silver gilded, hand-painted. Please refer to the 'Materials and Finish Options' Guide for further information.

**Decorative Coiling Options:**

Standard: Natural Cotton Cord  
 Upgrades: White, Natural, Henna, Iris Blue, Dark Brown, Grey and Black Leather Cord.  
 Custom leather colors available upon request.

**Certifications:**

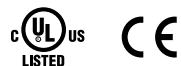

**Made in:**

New York, USA



Detail of Polished Nickel, Henna Leather Cord, Figure 1 suspension configuration

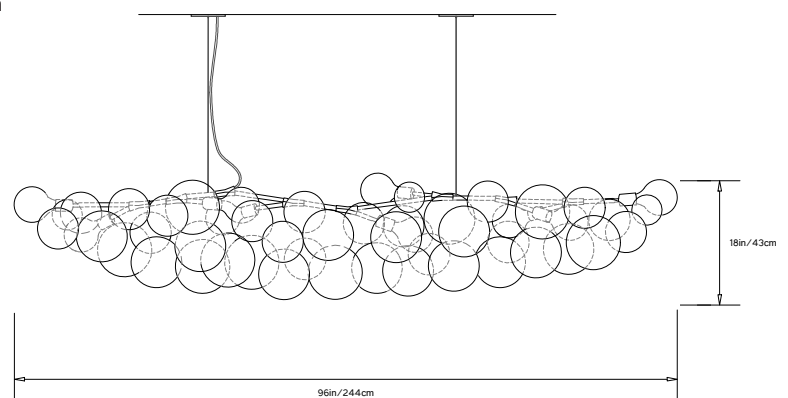

## WREATH 48 BUBBLE CHANDELIER

**Collection:**

Bubble Chandeliers

**Design Year:**

2015

**Dimensions:**

Diam 48in/122cm x H 22in/56cm  
 Also available in 60" and 76" diameter

**Weight:**

25lb/11.3kg

**Specifications (120V):**

8x G40 Bulbs (40W) included / Clear / E26 Medium  
 Screw Base / 240W total / 2400 Lumens total  
 LED Bulbs upon request

**Specifications (240V):**

8x G125 Bulbs (40W) included / Clear / E27 Medium  
 Screw Base / 240W total / 3112 Lumens total  
 LED Bulbs upon request

**Suspension:**

0.5in stem and 6in canopy in matching metal finish.  
 Ships with 2ft/60cm long stem that can be adjusted on  
 site. Longer pipe lengths available upon request.

**Materials:**

Machined brass, hand-blown glass globes, decorative  
 cotton or leather coiling

**Metal Finish Options:**

Standard: Satin Brass, Polished Nickel  
 Upgrades: Brushed Nickel, Antique Brass, Dark Bronze,  
 Black Brass

**Glass Globe Options:**

Standard: Clear  
 Upgrades: Opalescent, 24 gold/silver gilded,  
 hand-painted. Please refer to the 'Materials and Finish  
 Options' Guide for further information.

**Decorative Coiling Options:**

Standard: Natural Cotton Cord  
 Upgrades: White, Natural, Henna, Iris Blue,  
 Dark Brown, Grey and Black Leather Cord.  
 Custom leather colors available upon request.

**Certifications:**



**Made in:**

New York, USA



Detail of Satin Brass and Gray Leather Cord

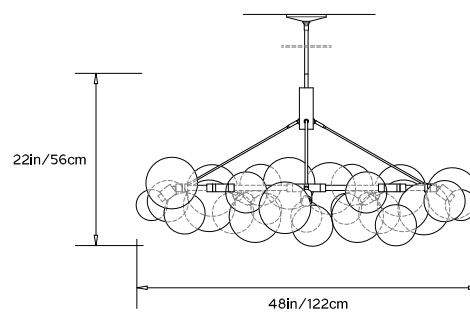
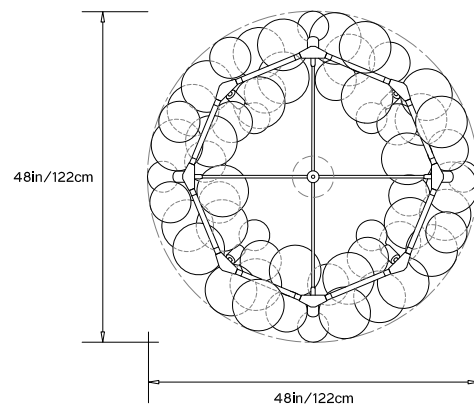

## WREATH 60 BUBBLE CHANDELIER

**Collection:**

Bubble Chandeliers

**Design Year:**

2015

**Dimensions:**

Diam 60in/152.4cm x H 27in/69cm  
 Also available in 48" and 76" diameter

**Weight:**

30lb/13.6kg

**Specifications (120V):**

8x G40 Bulbs (40W) included / Clear / E26 Medium  
 Screw Base / 240W total / 2400 Lumens total  
 LED Bulbs upon request

**Specifications (240V):**

8x G125 Bulbs (40W) included / Clear / E27 Medium  
 Screw Base / 240W total / 3112 Lumens total  
 LED Bulbs upon request

**Suspension:**

0.5in stem and 6in canopy in matching metal finish.  
 Ships with 2ft/60cm long stem that can be adjusted on  
 site. Longer pipe lengths available upon request.

**Materials:**

Machined brass, hand-blown glass globes, decorative  
 cotton or leather coiling

**Metal Finish Options:**

Standard: Satin Brass, Polished Nickel  
 Upgrades: Brushed Nickel, Antique Brass, Dark Bronze,  
 Black Brass

**Glass Globe Options:**

Standard: Clear  
 Upgrades: Opalescent, 24 gold/silver gilded,  
 hand-painted. Please refer to the 'Materials and Finish  
 Options' Guide for further information.

**Decorative Coiling Options:**

Standard: Natural Cotton Cord  
 Upgrades: White, Natural, Henna, Iris Blue,  
 Dark Brown, Grey and Black Leather Cord.  
 Custom leather colors available upon request.

**Certifications:**



**Made in:**

New York, USA



Detail of Satin Brass and Gray Leather Cord

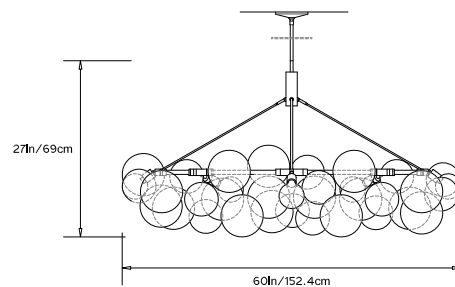
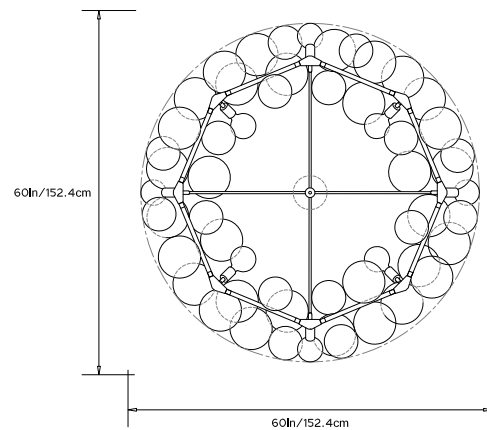

## WREATH 76 BUBBLE CHANDELIER

**Collection:**

Bubble Chandeliers

**Design Year:**

2015

**Dimensions:**

Diam 76in/193cm x H 34in/86.4cm  
 Also available in 48" and 60" diameter

**Weight:**

35lb/15.8kg

**Specifications (120V):**

8x G40 Bulbs (40W) included / Clear / E26 Medium Screw Base / 240W total / 2400 Lumens total LED Bulbs upon request

**Specifications (240V):**

8x G125 Bulbs (40W) included / Clear / E27 Medium Screw Base / 240W total / 3112 Lumens total LED Bulbs upon request

**Suspension:**

0.5in stem and 6in canopy in matching metal finish. Ships with 2ft/60cm long stem that can be adjusted on site. Longer pipe lengths available upon request.

**Materials:**

Machined brass, hand-blown glass globes, decorative cotton or leather coiling

**Metal Finish Options:**

Standard: Satin Brass, Polished Nickel  
 Upgrades: Brushed Nickel, Antique Brass, Dark Bronze, Black Brass

**Glass Globe Options:**

Standard: Clear  
 Upgrades: Opalescent, 24 gold/silver gilded, hand-painted. Please refer to the 'Materials and Finish Options' Guide for further information.

**Decorative Coiling Options:**

Standard: Natural Cotton Cord  
 Upgrades: White, Natural, Henna, Iris Blue, Dark Brown, Grey and Black Leather Cord.  
 Custom leather colors available upon request.

**Certifications:**

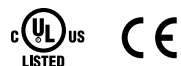

**Made in:**

New York, USA



Pictured with Satin Brass and Gray Leather Cord

