

CONTENTS

LONG BUBBLE CHANDELIER - Center Junction Box

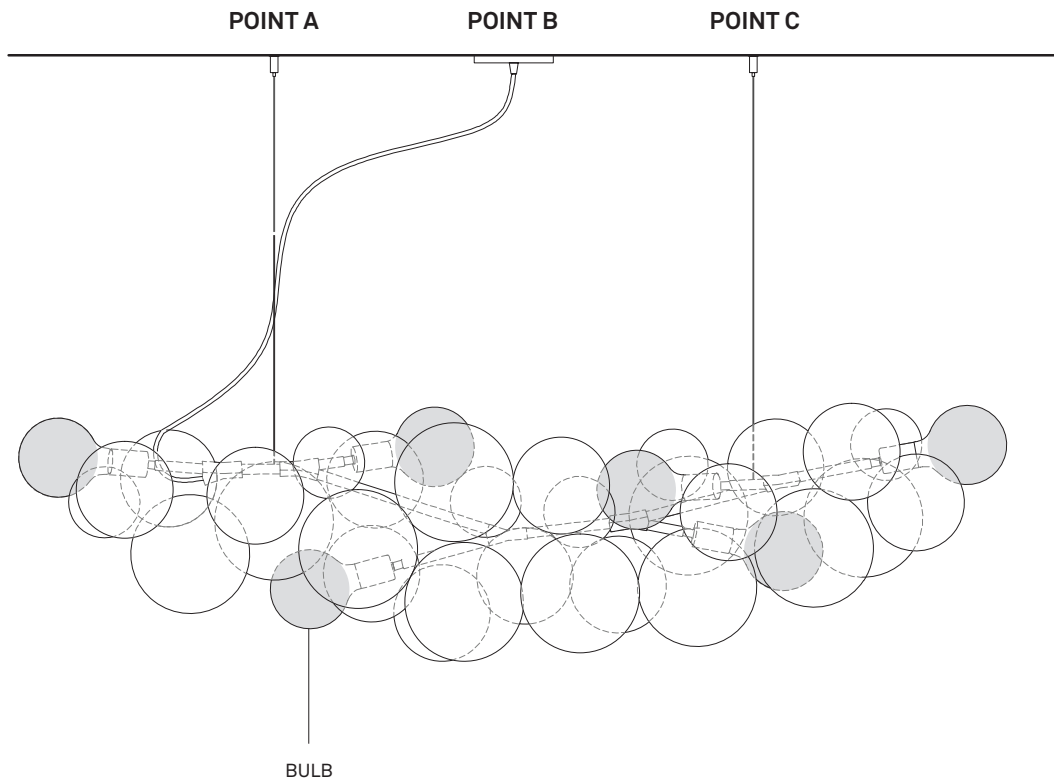

LAMPING

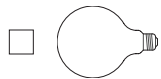

SIX G40 CLEAR INCANDESCENT BULBS
40W / 60W

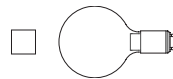

SIX LED 2-PIN BULBS
95 CRI - 2700K - 500 LUMENS

INSTALLATION NOTE

This product must be installed in accordance with the applicable installation code by a person familiar with the construction and operation of the product and the hazards involved.

HARDWARE

POINT A / C

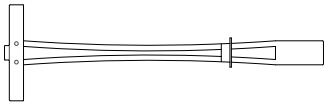

A TOGGLE BOLT (2)

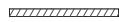

B THREADED ROD (2)

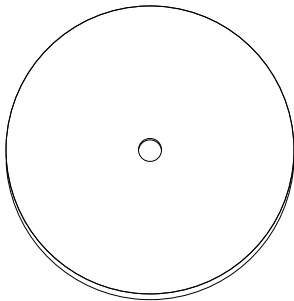

**C CANOPY
(2 IF REQUESTED)**



D WASHER (2)

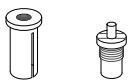

PART 1 PART 2

E 2-PART COUPLER (2)

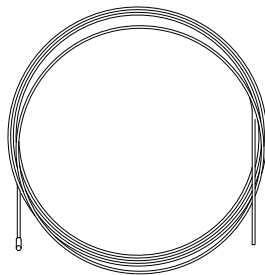

**F 1/16" STEEL CABLE WITH
DIE-CAST TERMINAL (2)**



G FERRULE (2)

POINT B

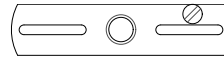

**H CROSS BAR / GROUND
SCREW**



I STRAIN RELIEF

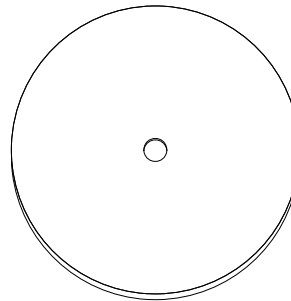

J CANOPY



K THREADED NIPPLE



L ZIP TIES (2)



M HEX NUTS (2)



N BUSHING



O STRAIN RELIEF

INSTALLATION

- 1 **While installing fixture, leave bubble wrap pouches on glass globes until installation is complete.**
 To start, leave fixture suspended in crate or rest carefully on floor.
- 2 Verify distance between suspension loops on fixture. Locate suspension points A and C equidistant from center of junction box.
- 3 Verify ceiling construction at point A and C. We recommend drilling a pilot hole to check for internal framing or blocking even if a hollow dry wall ceiling is assumed.

Hollow Ceiling: Drill a 0.5" hole and install toggle bolts (A). Install threaded rods (B), canopies (C), washers (D) and part 1 of cable couplers (E) to toggle bolts.

Internal Framing: Secure part 1 of cable coupler with screw into framing. Make sure screw is secure and can hold at least 15 lbs. Additional hardware and/or anchors may be necessary.
- 4 Insert each steel cable (F) through loop on fixture to allow for ferrule and terminal at end of cable to make a closed loop. Crimp each ferrule (G) tightly to create a permanent loop.
- 5 Insert each steel cable through part 2 of cable coupler and pull part 2 to roughly the same location along each steel cable.
- 6 **With two people, one holding each steel cable, raise fixture carefully.** You can also hold fixture at junction points above the fixture. Thread part 2 into part 1 of cable coupler at ceiling while holding fixture.
- 7 Height of fixture can be fine-tuned with cable couplers. To raise fixture, pull cable that exits part 1 of cable coupler. To lower fixture, press plunger of part 2 **while holding fixture.**
- 8 At point B, attach cross bar (H) to junction box.
- 9 Thread lamp cord through strain relief (I) and canopy (J) as shown in diagram. Secure threaded nipple (K) into center hole of cross bar and thread lamp cord through.
- 10 Leave enough slack in lamp cord to create desired figure. We suggest a subtle S-curve. Use zip ties (L) to aid in draping cord.
- 11 Thread hex nuts (M) and bushing (N) on to nipple. Install strain relief (O).
- 12 Make necessary electrical connections in junction box. Connect white (neutral) and black (hot) leads accordingly. Connect grounding wire to crossbar.
- 13 Raise canopy and strain relief against ceiling and tighten set screw on strain relief.
- 14 Once final adjustments have been made, cut excess steel cable.
- 15 **Remove bubble wrap bags before turning on fixture to avoid melting of plastic.** Bags are secured with staples. Remove carefully to avoid scratching fixture's surfaces. Begin with top layer of globes and work towards bottom layers. Avoid knocking glass globes into each other.
- 16 You are done. Enjoy!

POINTS A & C: Suspension Points

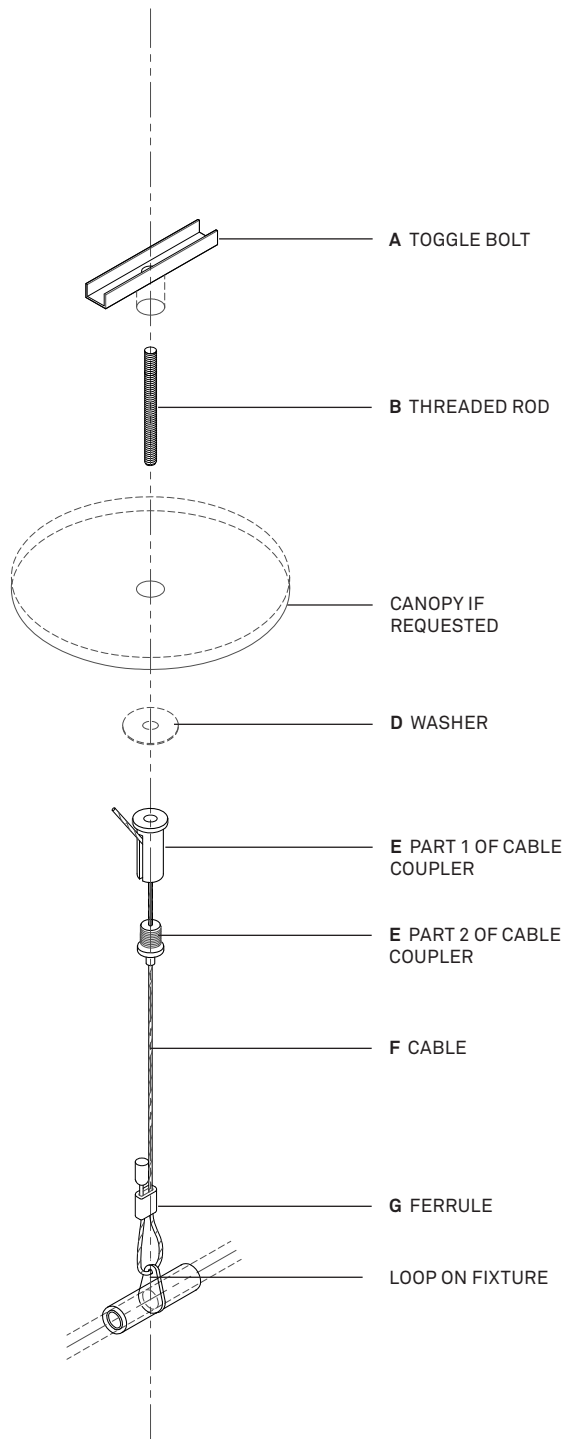

POINT B: Junction Box

