

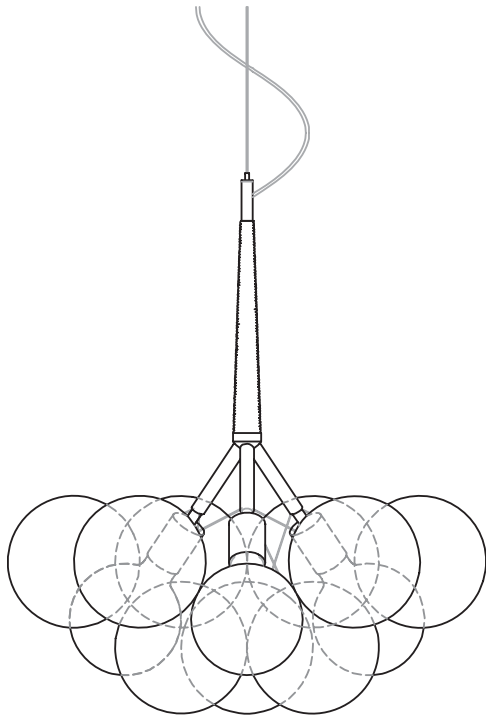

CONTENTS

LARGE BUBBLE CHANDELIER

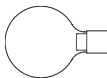

LAMPING

-  3 X G40 CLEAR INCANDESCENT BULBS
40W / 60W
-  3 X LED 2-PIN BULBS
95 CRI - 2700K - 500 LUMENS

INSTALLATION NOTE

This product must be installed in accordance with the applicable installation code by a person familiar with the construction and operation of the product and the hazards involved.

HARDWARE

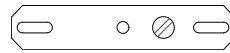

A CROSS BAR / GROUND SCREW



B 1/4"-20 SCREW



C THREADED ROD / HEX NUTS (2)

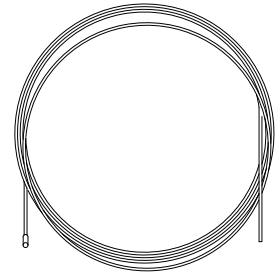

D 1/16" STEEL CABLE WITH DIE-CAST TERMINAL



E 2-PART CABLE COUPLER

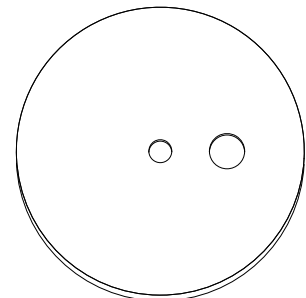

F CANOPY



G CABLE CORD HOLDER



H CABLE GRIPPER



I CABLE STOP



J STRAIN RELIEF



K ZIP TIES (2)

INSTALLATION

- 1 When handling fixture, hold at main stem. **Leave bubble wrap pouches on glass globes and protective foam on fixture until installation is complete.**
- 2 Attach cross bar (A) to junction box with 1/4"-20 screw (B) inserted through center hole. If it is necessary to make a longer connection, use threaded rod (C) and hex nuts.
- 3 Feed steel cable (D) through 2-part cable coupler (E) so that attached die-cast terminal sits inside coupler.
- 4 Place canopy (F) over junction box and secure by threading cable coupler on to 1/4"-20 screw.
- 5 Insert cable cord holder (G) on to steel cable and power cord. We recommend placing holder 12" above fixture or as desired. For low ceilings, holder may not be necessary.
- 6 Place cable gripper (H) at desired height along steel cable. Adjust height by depressing plunger.
- 7 **Crimp copper cable stop (I) right below gripper to avoid accidental release of gripper. Cut off excess steel cable below stop.**
- 8 Thread cable gripper into top cap of fixture.
- 9 Thread power cord through canopy and secure with strain relief bushing (J). Zip ties (K) are provided to aid in draping power cord if needed or desired. We like a subtle S-curve in cord for larger drop heights.
- 10 Release canopy by unthreading part 2 of cable coupler. Make necessary electrical connections in junction box. Connect white (neutral) and black (hot) leads accordingly. Once connections have been made and tested, raise canopy and thread part 2 in place.
- 11 **Remove bubble wrap bags before turning on fixture to avoid melting of plastic.** Bags are secured with staples. Remove carefully to avoid scratching fixture's surfaces. Begin with top layer of globes and work towards bottom layers. Avoid knocking glass globes into each other.
- 12 When removing bubble bags pay close attention to numbered stickers. Consult diagram at end of document for correct placement.
- 13 You are done. Enjoy!

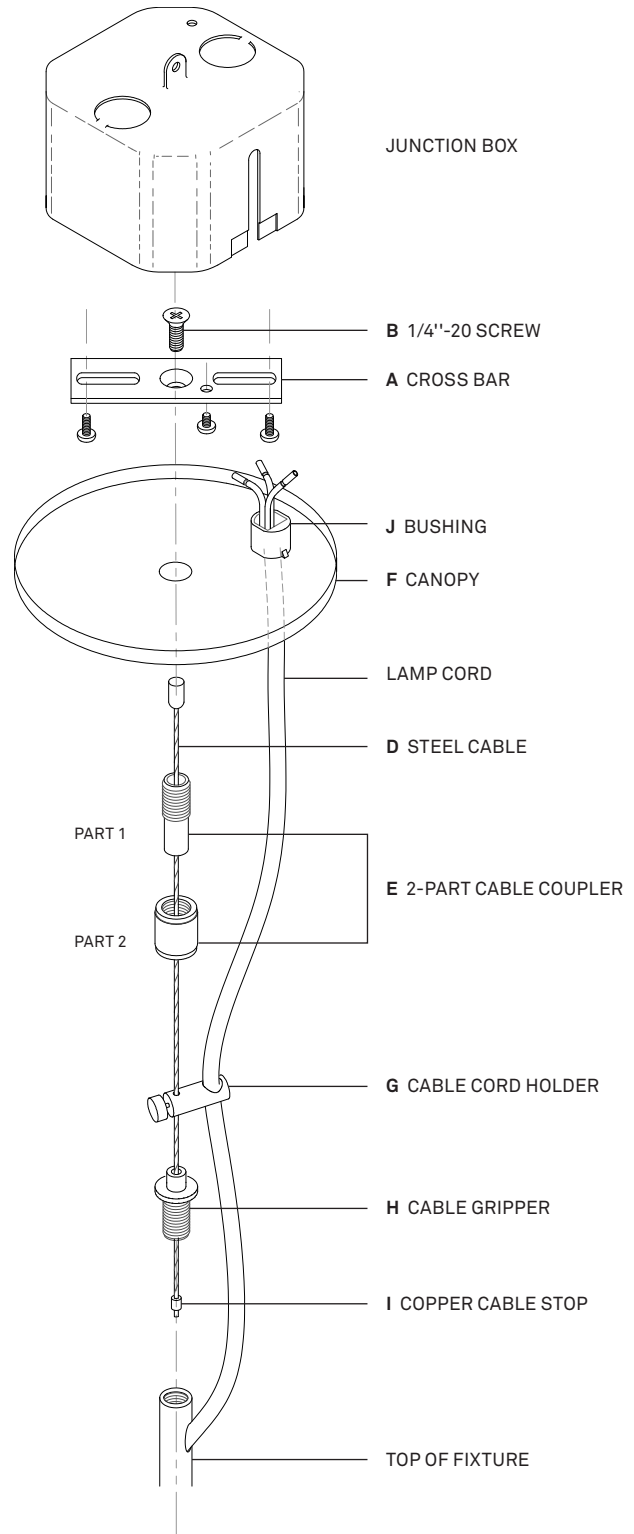

ARRANGEMENT

Use the diagram to ensure your bubble chandelier has been installed with the correct geometry.

Take care that no strings are crossed and that globes in each level are hanging evenly.

1 - Lowest level

2 - Highest level

